

# Low Voltage Male/Female Insulators, 1.575"

## Data Solutions

### CATALOG NUMBER

**ISOTP40F8M8**



### CERTIFICATIONS



### FEATURES

Halogen free

High resistance to leakage current

Great stability of electrical and mechanical parameters

Fiberglass reinforced

UL® Recognized in E125470 and evaluated for dielectric withstand rating of 1,500 VAC/DC

RoHS compliant

### PRODUCT ATTRIBUTES

Article Number: 542050

Material: Steel; Glass Fibre Reinforced Polyamide

Finish: Electrogalvanized

Working Temperature: -40 to 130°C

Insulation Voltage: 1000; 1500

Flammability Rating: UL® 94V-0

Complies With: IEC® 60695-2-11 (Glow Wire Test 960 °C)

Height (H): 40mm

Hex Width (W): 46mm

Depth (D): 53mm

Diameter (Ø): 40mm

Thread Size 1 (TS1): M8

Thread Length (TL): 17mm

Thread Size 2 (TS2): M8

Thread Depth (TD): 8mm

Static Load 1 (F1): 11000daN

Static Load 2 (F2): 6500daN

Unit Weight: 0.11kg

## DIAGRAMS

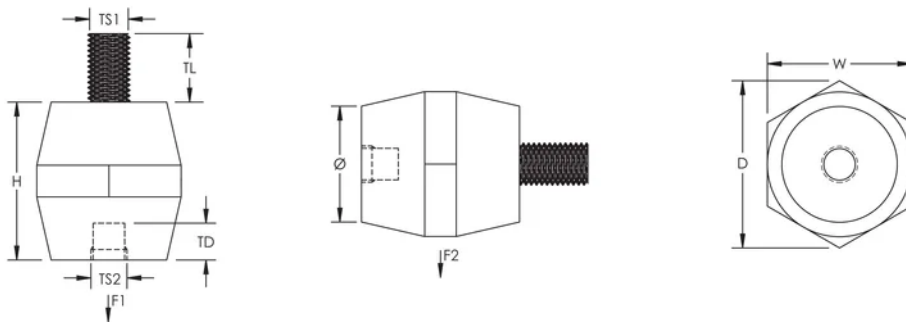

## WARNING

nVent products shall be installed and used only as indicated in nVent's product instruction sheets and training materials. Instruction sheets are available at [www.nvent.com](http://www.nvent.com) and from your nVent customer service representative. Improper installation, misuse, misapplication or other failure to completely follow nVent's instructions and warnings may cause product malfunction, property damage, serious bodily injury and death and/or void your warranty.



Our powerful portfolio of brands:

**CADDY   ERICO   HOFFMAN   ILSCO   SCHROFF   TRACHTE**